

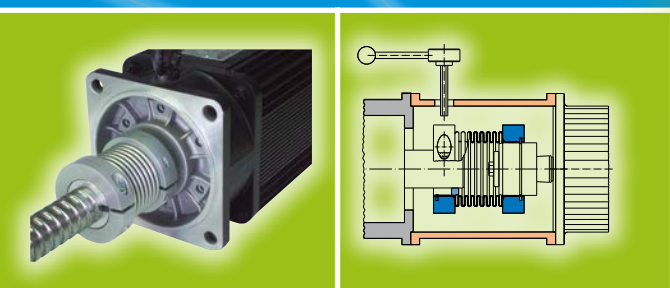

your reliable partner

smartflex®

**The perfect
shaft coupling**

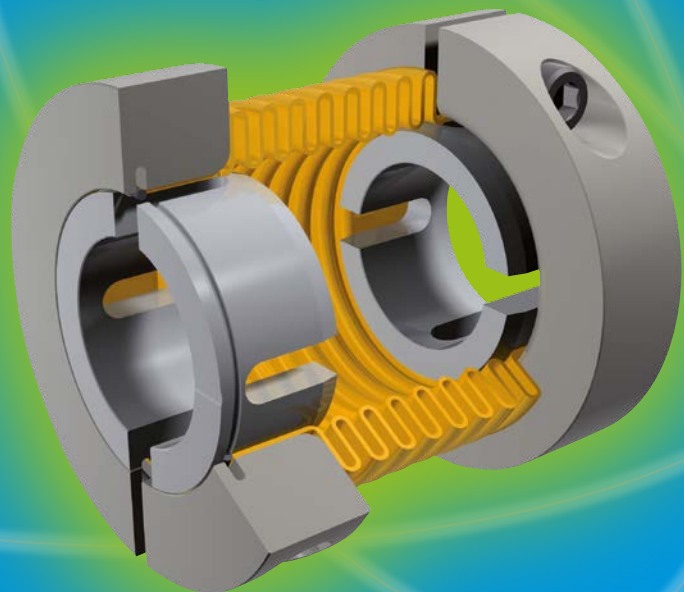

smartflex[®]

Superior technology at a lower cost

Your advantages when using the new smartflex[®] coupling

Lower costs

- extremely advantageous cost/performance ratio due to the ingeniously simple construction
- time-saving installation due to simple and fast shaft securement

Higher precision

- backlash-free shaft securement
- backlash-free torque transmission
- high torsional rigidity

Faster availability

- modular construction ensures fastest possible delivery
- delivery of standard stock items within 24 hours

Compensation of much larger shaft misalignments

- up to three times higher misalignment compensation capability for radial shaft misalignment than on standard steel bellows couplings
- low restoring forces on the shaft bearings

More drive dynamics

- minimal mass moment of inertia
- safe torque transmission even at high speeds

Higher operational safety

- high misalignment compensation capability eliminates the most common failure causes suffered by previous generations of steel bellows

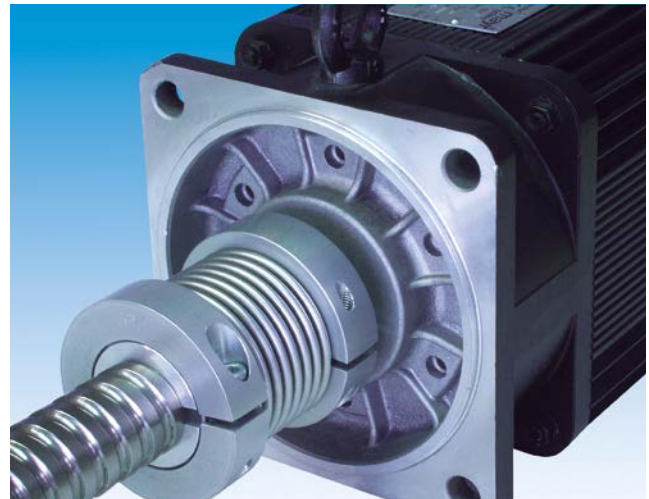

The perfect servo coupling

Backlash-free, torsionally rigid steel bellows coupling for flexible compensation of shaft misalignment



According to German notation, decimal points in this catalogue are represented with a comma (e.g. 0,5 instead of 0.5).

High availability due to flexible modular construction



The smartflex[®] coupling steel bellows and clamping rings are the same for all designs within a construction size. They are adapted via reducing bushings to the required shaft diameter. These bushings can be engaged easily and quickly into the clamping rings.

This concept guarantees you the lowest possible storage numbers and high availability.

The Optimum Shaft Coupling for Every Drive





Each drive has its own specific characteristics and therefore places different demands on the couplings which transmit the torque from one shaft to the second and which compensate for the resulting shaft misalignments. In most cases only backlash-free couplings are able to meet the requirements for high-speed, dynamic or reversing precision drives.

mayr® power transmission has three of the most established and most attractive backlash-free shaft couplings in its programme:

- **Disk pack couplings,**
- **Steel bellows couplings** and
- **Elastomer couplings**

Therefore, mayr® offers an optimum solution for many different drives.

Overview: Backlash-free Shaft Couplings Types, Designs, Characteristics

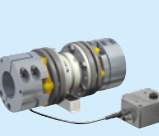
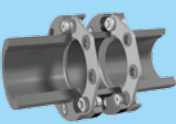
primeflex Steel bellows couplings	ROBA®-DS Servo couplings	smartflex® Steel bellows couplings	ROBA®-ES Elastomer couplings	ROBA®-DS All-steel couplings	ROBA®-DSM Torque measurement coupling	ROBA®-DS All-steel couplings
						
Flexible element						
Steel bellows	Disk pack	Steel bellows	Plastic element	Disk pack	Disk pack	Disk pack
Nominal torque range in Nm						
24 – 120	35 – 150	16 – 700	4 – 1250	190 – 24000	190 – 1600	22000 – 110000
Max. permitted speed in rpm						
8000	22500	10000	28000	13600	9500	3600
Shaft diameter in mm						
10 – 45	10 – 45	8 – 85	6 – 80	14 – 170	14 – 110	on request
Max. permanent operation temp. in °C						
120	100	120	100	250	70	250
Torsionally rigid						
x	x	x		x	x	x
Torsionally flexible						
			x			
Vibration damping						
			x			
Can be combined with safety clutch						
x	x	x	x	x		x
Can be integrated with torque measurement						
				x		x
Distance between shaft ends						
graduated	variable	graduated	fixed	variable	fixed	variable
Single-joint design						
	x		x	x		x
• Shaft misalignment compensation axial						
	x		x	x		x
• Shaft misalignment compensation radial						
			x			
• Shaft misalignment compensation angular						
	x		x	x		x
Double-joint design						
x	x	x		x	x	x
• Shaft misalignment compensation axial						
x	x	x		x	x	x
• Shaft misalignment compensation radial						
x	x	x		x	x	x
• Shaft misalignment compensation angular						
x	x	x		x	x	x
ATEX design acc. 94/9 EC						
	x		x	x		
Product catalogue						
P.933.V	K.950.V	K.932.V	K.940.V	K.950.V	P.971005.V	K.950.V

Standard Design

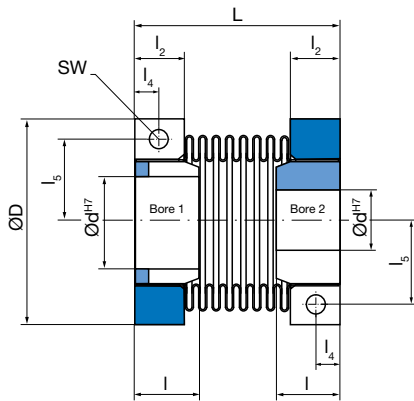

Fig. 1: Type 932.333

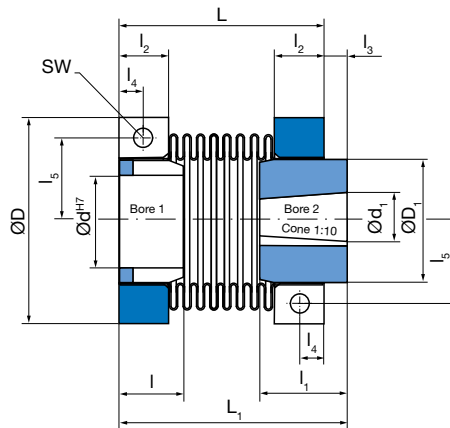

Fig. 2: Type 932.343
(only sizes 1 and 2)

Short Construction Length

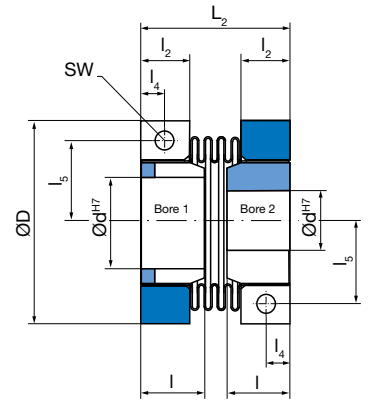

Fig. 3: Type 932.433
(only sizes 1 – 5)
(reducing bushing with tapered bore on request)

Technical Data			Size						
			0	1	2	3	4	5	
Nominal torque		T_{KN} [Nm]	16	40	100	200	400	700	
Minimum hub bore ¹⁾		d_{min} [mm]	8	11	16	18	30	40	
Maximum hub bore ¹⁾		d_{max} [mm]	19	25	36	50	62	85	
Tapered hub bore		d_1 [mm]	-	16	16	-	-	-	
Maximum speed		n_{max} [rpm]	10 000	8 000	6 000	4 000	3 000	2 500	
Screws	tightening torque \pm 5%	T_A [Nm]	10	14	17	41	77	133	
	wrench opening	SW [mm]	4	5	5	6	8	10	
Permitted misalignments ²⁾	permitted axial displacement	Type 932.3_3	ΔK_a [mm]	0,4	0,6	0,8	0,8	0,8	0,6
		Type 932.433	ΔK_a [mm]	-	0,3	0,4	0,4	0,6	0,6
	permitted radial misalignments	Type 932.3_3	ΔK_r [mm]	0,3	0,4	0,5	0,5	0,5	0,5
		Type 932.433	ΔK_r [mm]	-	0,1	0,1	0,1	0,1	0,1
permitted angular misalignments	Type 932.3_3	ΔK_w [°]	3	3	3	3	1,5	1,0	
	Type 932.433	ΔK_w [°]	-	1,5	1,5	1,5	1,2	1,0	
Spring stiffness	axial spring stiffness	Type 932.3_3	C_{ax} [N/mm]	50	70	90	120	172	156
		Type 932.433	C_{ax} [N/mm]	-	140	180	240	175	187
	torsion	Type 932.3_3	C_T [Nm/rad]	4 000	9 000	22 000	50 000	125 000	305 000
		Type 932.433	C_T [Nm/rad]	-	18 000	44 000	100 000	168 000	380 000

1) Please observe transmittable torques and preferred bores according to Tables 1 and 2 on page 5.
2) The permitted misalignments must not simultaneously reach the maximal values.

Dimension [mm]	Size					
	0	1	2	3	4	5
D	46	57	72	94	118	146
D ₁	-	29,9	42,2	-	-	-
L	49,5	59,3	72	90,3	115	124
L ₁	-	71,5	82	-	-	-
L ₂	-	43,7	52,5	65,6	87	98
l	15	18	20	26	32	36
l ₁	-	30	30	-	-	-
l ₂	13	15	17	22	28	31
l ₃	-	12	10	-	-	-
l ₄	6,5	7,5	9	11,5	14	15,5
l ₅	15,2	20	27	34,5	44	56

Mass moment of inertia [10 ⁻⁶ kgm ²]	Size					
	0	1	2	3	4	5
Type 932.333	36	104	330	1210	3420	8450
Type 932.343	-	107	340	-	-	-
Type 932.433	-	94	290	1060	3290	8400

Weight [kg]	Size					
	0	1	2	3	4	5
Type 932.333	0,132	0,245	0,467	1,00	1,80	2,80
Type 932.343	-	0,265	0,521	-	-	-
Type 932.433	-	0,217	0,400	0,876	1,70	2,73

Transmittable torques of the clamping connection - dependent on bore - Type 932.__3

	Bore	Size					
		0	1	2	3	4	5
Frictionally-locking transmittable torques of the clamping connection	Ø8	9,6	-	-	-	-	-
	Ø9	11	-	-	-	-	-
	Ø11	14	24	-	-	-	-
	Ø12	16	26	-	-	-	-
	Ø14	16	31	-	-	-	-
	Ø16	16	35	60	-	-	-
	Ø18	16	39	68	120	-	-
	Ø19	16	40	72	127	-	-
	Ø20	-	40	75	133	-	-
	Ø22	-	40	84	147	-	-
	Ø25	-	40	100	167	-	-
	Ø28	-	-	100	187	-	-
	Ø30	-	-	100	200	240	-
	Ø32	-	-	100	200	256	-
	Ø35	-	-	100	200	280	-
	Ø36	-	-	100	200	290	-
	Ø38	-	-	-	200	305	-
	Ø40	-	-	-	200	320	420
	Ø42	-	-	-	200	340	440
	Ø45	-	-	-	200	360	475
	Ø48	-	-	-	200	390	510
	Ø50	-	-	-	200	400	530
	Ø55	-	-	-	-	400	580
	Ø60	-	-	-	-	400	640
	Ø62	-	-	-	-	400	660
Ø65	-	-	-	-	-	690	
Ø70	-	-	-	-	-	700	
Ø75	-	-	-	-	-	700	
Ø80	-	-	-	-	-	700	
Ø85	-	-	-	-	-	700	

Table 1

Preferred bores

	Size																				
	0		1		2		3				4				5						
Preferred bores Ø d ^{H7}	-	10	-	20	-	20	30	-	20	30	40	50	30	40	50	60	40	50	60	70	80
	-	11	11	-	-	-	-	-	-	-	-	-	-	-	-	-	-	-	-	-	-
	-	12	12	22	-	22	32	-	22	32	42	-	32	42	-	62	42	-	62	-	-
	-	-	13	-	-	-	-	-	-	-	-	-	-	-	-	-	-	-	-	-	-
	-	14	14	24	-	24	-	-	24	-	-	-	-	-	-	-	-	-	-	-	-
	-	15	15	25	-	25	35	-	25	35	45	-	35	45	55	-	45	55	65	75	85
	-	16	16	-	16	26	36	-	26	36	-	-	36	48	-	-	-	-	-	-	-
	-	-	-	-	17	27	-	-	27	-	-	-	-	-	-	-	-	-	-	-	-
	8	18	18	-	18	28	-	18	28	38	48	-	38	-	-	-	48	-	-	-	-
	9	19	19	-	19	-	-	19	-	-	-	-	-	-	-	-	-	-	-	-	-

Table 2

Order number

—	/	9	3	2	.	—	—	3	/	—	/	—
▲						▲	▲			▲		▲
Sizes 0 to 5		long steel bellows		3		3	Cylindrical bores on both sides ³⁾		Bore 1 Ø d ^{H7}		Bore 2 Ø d ₁	
		short steel bellows		4		4	Cylindrical bore and tapered bore ^{4) 5)}		(see Table page 4)		(see Table page 4)	

Example: 2 / 932.343 / Ød 20 / Ød₁ 16

- 3) Type 932.433 (cylindrical bores on both sides combined with short steel bellows): only sizes 1 – 5
- 4) Type 932.343 (cylindrical bore and tapered bore combined with long steel bellows): only sizes 1 and 2
- 5) Type 932.443 (cylindrical bore and tapered bore combined with short steel bellows): on request

Size Selection

Coupling Size Selection

Please carry out dimensioning using Diagram 1 (Sizes 0 – 2) or Diagram 2 (Sizes 3 – 5) with “Torque M (Nm)” and “Misalignment (%)”:

1. Determining the co-ordinates “torque M”:

- Find the maximum operating torque.
- Multiply the operating torque with the values from Table 3 (temperature factor) and Table 4 (service factor) (interpolate the interim values).

2. Determining the co-ordinates “misalignment”:

- Determine the individual shaft misalignments in %, measured using the “Permitted shaft misalignments” for the intended coupling size (see Technical Data, page 4).
Example for size 2: 0,2 mm axial displacement equals 25 % of the permitted value 0,8 mm.
- Add together the individual percent values. The sum total must be below 100 %.

3. Write both the defined co-ordinate values into the respective diagram.

The point of intersection must lie below the characteristic curve of the intended coupling size.

4. If the point of intersection lies above the characteristic curve,

- choose a larger coupling,
- reduce the shaft misalignments or
- contact the manufacturers.

Diagram 1
Sizes 0 – 2

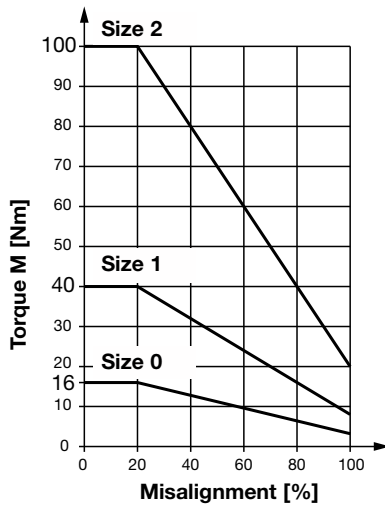
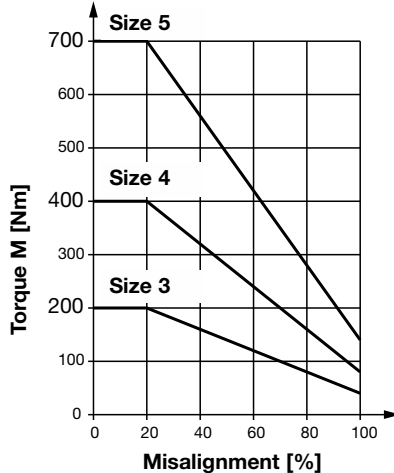

Diagram 2
Sizes 3 – 5



Technical Explanations

Parts List

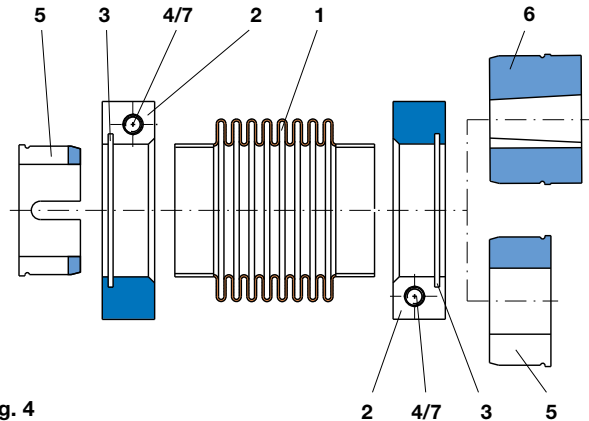

Fig. 4

- | | |
|------------------|--------------------------------------|
| 1 Steel bellows | 5 Reducing bushing |
| 2 Clamping ring | 6 Reducing bushing with tapered bore |
| 3 Holding spring | 7 Washer |
| 4 Cap screw | |

State of Delivery

- packed individually in folding boxes, or
- plugged together and secured with cable ties
- Bores in the reducing bushings (5) and reducing bushing with tapered bore (6) have H7 tolerances

Adapting to the Shaft Diameter

The reducing bushing (5) can be pressed out of the clamping ring (2) using axial pressure (manually or with a small hand press) and replaced.

Shaft Requirements

- Surface quality: 1,6 μm
- Run-out accuracy: 0,01 mm
- Minimum tensile strength: 500 N/mm²
- Tolerance: h6

For all other tolerances, please contact the manufacturer.

Function

smartflex®-couplings transmit the torque backlash-free and compensate for radial, axial and angular shaft misalignments.

Temperature Resistance

Resistant against permanent temperatures of up to 120 °C (devices resistant to higher temperatures available on request)

Installation Position

Can be defined by the user.

	Temperature			
	50 °C	80 °C	100 °C	120 °C
Temperature factor f_t	1	1,1	1,2	1,3

Table 3

	Load		
	Even	Uneven	Impact
Service factor f_b	1,5	2	2,5 – 4

For drives in machine tools (servo motors), we recommend f_b values of 1,5

Table 4

Short Description – Coupling Installation

For a detailed installation description, please see the Installation and Operational Instructions corresponding to the respective product **B.9.8.GB**.

Important Installation Guidelines

- Wash off the conserving layer in the bores with paraffin, white spirit, cleaner solvent or similar.
- The bores and the shafts must be grease and oil-free.
- The permitted shaft misalignment must not be exceeded.
- Avoid damage to the steel bellows (1) before and during installation.
- The clamping ring (2) with the holding spring (3) must be engaged in the reducing bushing (5) or reducing bushing with tapered bore (6).
- If a reducing bushing is dismantled or re-installed more than 5 times, the snap ring groove may deform, making it unpermitted for use.
- In order to transfer the defined torques in Table 1 (page 5) correctly, the slots in the steel bellows (1), clamping ring (2) and reducing bushing (5) must be aligned (see Fig. 5).

Coupling Installation Type 932.333 (Fig. 1, page 4) and Type 932.433 (Fig. 3, page 4)

– see also Fig. 6 and Fig. 8

1. Please ensure that the coupling can be easily pushed onto both shafts.
2. Push the entire coupling over the whole length of the reducing bushing (5) onto a shaft.
3. Make sure that the steel bellows (1) is pushed between the clamping ring (2) and the reducing bushing (5) up to its limit, and that the slots in the steel bellows, clamping ring (2) and reducing bushing (5) are aligned (see Fig. 5).
4. Tighten the cap screw (4). The screw tightening torques (see Technical Data, page 4) must be observed.
5. Push the second shaft over the entire length of the reducing bushing (5) into the coupling.
6. Make sure that the steel bellows (1) is pushed between the clamping ring (2) and the reducing bushing (5) up to its limit, and that the slots in the steel bellows, clamping ring (2) and reducing bushing (5) are aligned (see Fig. 5).
7. Tighten the cap screw (4). The screw tightening torques (see Technical Data, page 4) must be observed.

Coupling Installation Type 932.343 (Fig. 2, page 4)

– see also Fig. 7 and Fig. 8

1. Remove the clamping ring (2) with the protruding reducing bushing with tapered bore (6) from the coupling.
2. If necessary, insert the key into the conical shaft.
3. Push the reducing bushing with tapered bore (6) onto the conical shaft.
4. Secure the reducing bushing with tapered bore (6) using a nut or screw with press cover.
5. Push the rest of the coupling with the open steel bellows side up to its limit between the clamping ring (2) and reducing bushing with tapered bore (6).
6. Tighten the cap screw (4). The screw tightening torque (see Technical Data, page 4) must be observed.
7. Push the second shaft over the entire length of the reducing bushing (5) into the coupling.
8. Make sure that the steel bellows (1) is pushed between the clamping ring (2) and the reducing bushing (5) up to its limit, and that the slots in the steel bellows, clamping ring (2) and reducing bushing (5) are aligned (see Fig. 5).
9. Tighten the cap screws (4). The screw tightening torques (see Technical Data, page 4) must be observed.

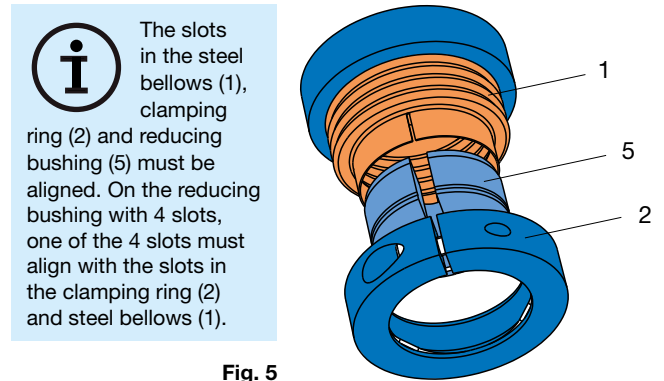
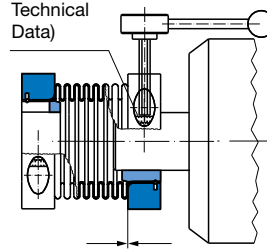

Fig. 5

Coupling Installation onto Cylindrical Shaft

Cap screw (4)
Observe tightening torque!
(see Technical Data)



Cap screw (4)
Observe tightening torque!
(see Technical Data)

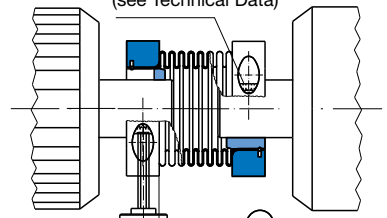

Fig. 6

Coupling Installation onto Conical Shaft

Cap screw (4)
Observe tightening torque!
(see Technical Data)

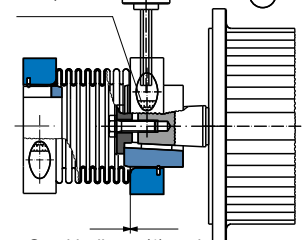
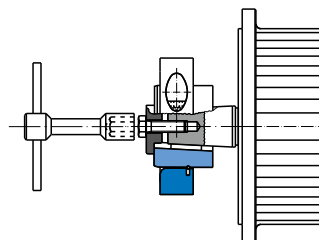

Fig. 7

Coupling Installation into a Bell Housing

Apply the tools carefully.
The clamping ring (2) is not secured against turning

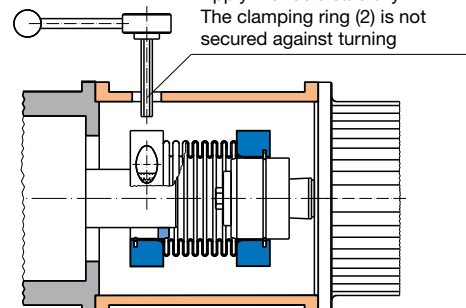

Fig. 8



Headquarters

Chr. Mayr GmbH + Co. KG
Eichenstraße 1, D-87665 Mauerstetten
Tel.: +49 83 41/8 04-0, Fax: +49 83 41/80 44 21
www.mayr.com, E-Mail: info@mayr.com



your reliable partner

Service Germany

Baden-Württemberg

Esslinger Straße 7
 70771 Leinfelden-Echterdingen
 Tel.: 07 11/45 96 01 0
 Fax: 07 11/45 96 01 10

Bavaria

Eichenstraße 1
 87665 Mauerstetten
 Tel.: 0 83 41/80 41 04
 Fax: 0 83 41/80 44 23

Chemnitz

Bornaer Straße 205
 09114 Chemnitz
 Tel.: 03 71/4 74 18 96
 Fax: 03 71/4 74 18 95

Franken

Unterer Markt 9
 91217 Hersbruck
 Tel.: 0 91 51/81 48 64
 Fax: 0 91 51/81 62 45

Hagen

Im Langenstück 6
 58093 Hagen
 Tel.: 0 23 31/78 03 0
 Fax: 0 23 31/78 03 25

Kamen

Lünener Straße 211
 59174 Kamen
 Tel.: 0 23 07/23 63 85
 Fax: 0 23 07/24 26 74

North

Schiefer Brink 8
 32699 Extertal
 Tel.: 0 57 54/9 20 77
 Fax: 0 57 54/9 20 78

Rhine-Main

Hans-Böckler-Straße 6
 64823 Groß-Umstadt
 Tel.: 0 60 78/7 82 53 37
 Fax: 0 60 78/9 30 08 00

Branch office

China

Mayr Zhangjiagang
 Power Transmission Co., Ltd.
 Changxing Road No. 16,
 215600 Zhangjiagang
 Tel.: 05 12/58 91-75 65
 Fax: 05 12/58 91-75 66
 info@mayr-ptc.cn

Great Britain

Mayr Transmissions Ltd.
 Valley Road, Business Park
 Keighley, BD21 4LZ
 West Yorkshire
 Tel.: 0 15 35/66 39 00
 Fax: 0 15 35/66 32 61
 sales@mayr.co.uk

France

Mayr France S.A.S.
 Z.A.L. du Minopole
 Rue Nungesser et Coli
 62160 Bully-Les-Mines
 Tel.: 03.21.72.91.91
 Fax: 03.21.29.71.77
 contact@mayr.fr

Italy

Mayr Italia S.r.l.
 Viale Veneto, 3
 35020 Saonara (PD)
 Tel.: 0498/79 10 20
 Fax: 0498/79 10 22
 info@mayr-italia.it

Singapore

Mayr Transmission (S) PTE Ltd.
 No. 8 Boon Lay Way Unit 03-06,
 TradeHub 21
 Singapore 609964
 Tel.: 00 65/65 60 12 30
 Fax: 00 65/65 60 10 00
 info@mayr.com.sg

Switzerland

Mayr Kupplungen AG
 Tobelackerstrasse 11
 8212 Neuhausen am Rheinfall
 Tel.: 0 52/6 74 08 70
 Fax: 0 52/6 74 08 75
 info@mayr.ch

USA

Mayr Corporation
 4 North Street
 Waldwick
 NJ 07463
 Tel.: 2 01/4 45-72 10
 Fax: 2 01/4 45-80 19
 info@mayrcorp.com

Representatives

Australia

Regal Beloit Australia Pty Ltd.
 19 Corporate Ave
 03178 Rowville, Victoria
 Australien
 Tel.: 0 3/92 37 40 00
 Fax: 0 3/92 37 40 80
 salesAUvic@regalbeloit.com

India

National Engineering
 Company (NENCO)
 J-225, M.I.D.C.
 Bhosari Pune 411026
 Tel.: 0 20/27 13 00 29
 Fax: 0 20/27 13 02 29
 nenco@nenco.org

Japan

MATSUI Corporation
 2-4-7 Azabudai
 Minato-ku
 Tokyo 106-8641
 Tel.: 03/35 86-41 41
 Fax: 03/32 24 24 10
 k.goto@matsui-corp.co.jp

Netherlands

Groneman BV
 Amarilstraat 11
 7554 TV Hengelo OV
 Tel.: 074/2 55 11 40
 Fax: 074/2 55 11 09
 aandrijftechnik@groneman.nl

Poland

Wamex Sp. z o.o.
 ul. Pozaryskiego, 28
 04-703 Warszawa
 Tel.: 0 22/6 15 90 80
 Fax: 0 22/8 15 61 80
 wamex@wamex.com.pl

South Korea

Mayr Korea Co. Ltd.
 Room No.1002, 10th floor,
 Nex Zone, SK TECHNOPARK,
 77-1, SungSan-Dong,
 SungSan-Gu, Changwon, Korea
 Tel.: 0 55/2 62-40 24
 Fax: 0 55/2 62-40 25
 info@mayrkorea.com

Taiwan

German Tech Auto Co., Ltd.
 No. 28, Fenggong Zhong Road,
 Shengang Dist.,
 Taichung City 429, Taiwan R.O.C.
 Tel.: 04/25 15 05 66
 Fax: 04/25 15 24 13
 abby@zfgta.com.tw

Czech Republic

BMC - TECH s.r.o.
 Hvězdoslavova 29 b
 62700 Brno
 Tel.: 05/45 22 60 47
 Fax: 05/45 22 60 48
 info@bmc-tech.cz

More representatives:

Austria, Belgium, Brazil, Canada, Denmark, Finland, Greece, Hongkong, Hungary, Indonesia, Israel, Luxembourg, Malaysia, New Zealand, Norway, Philippines, Romania, Russia, Slovakia, Slovenia, South Africa, Spain, Sweden, Thailand, Turkey

You can find the complete address for the representative responsible for your area under www.mayr.com in the internet.